

StarLine M13



USER MANUAL

Version 1.02

GENERAL DESCRIPTION

StarLine M13 universal tracker offers an easy and economy vehicle positioning, live tracking and basic anti-theft security features.

Device can send text message with exact position and link to online map.

It can be quickly mounted in any road vehicles, motorcycles, quad bikes, boats and electric scooters.

Controlled object can be real time monitored on desktop at subscription free starline.online web service and StarLine 2 free mobile app.

Major benefits

- Universal input power for various means of transport
- Quick installation
- Rugged waterproof housing
- Lifetime free subscription tracking
- Geofence In / Out alert
- Tamper alert (shock sensor)
- Black box coordinates memory
- Remote engine cut

TECHNICAL SPECIFICATION

Features	Values
GSM cellular bands	850/900/1800/1900 MHz
SIM card	1 micro-SIM
GSM antenna	embedded
GPS+GLONASS receiver	embedded
Input power	9-90 V
Rated standby current	5 mA
Water resistance	IP65
Operating temperature	-40 ... +85 °C
Dimensions	72x30.2x13 mm
Weight	37 g

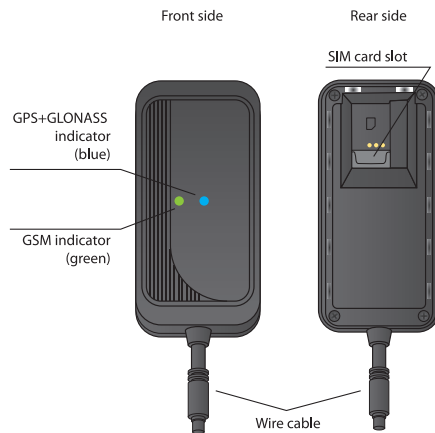

INSTALLATION RECOMMENDATIONS

Please install device with a qualified specialist assistance.

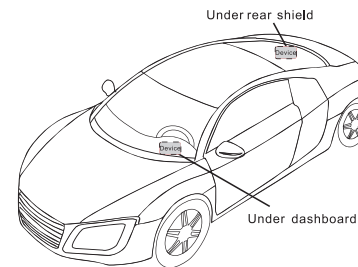

Note:

Device should be installed facing up towards the sky. The metal thermal barrier or heating layer on windshield may affect a signal. Change the mounting location to improve a signal strength.

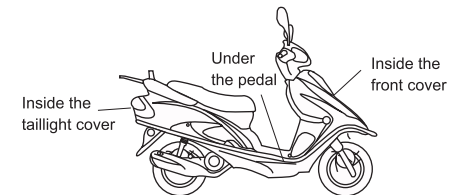
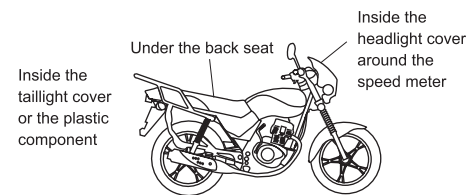
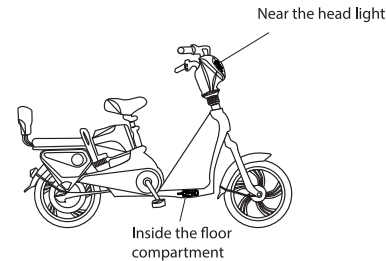
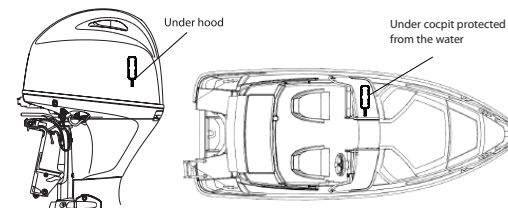

CONNECTION DIAGRAM

SIM card installation

Open tracker housing up with flat item and insert SIM card in the slot on the circuit board. Put the plastic cover back.

Sample NC engine cut connection diagram

Universal output (yellow wire) can be used for remote engine blocking like in example below. Max load for universal output – **200 mA (-)**.

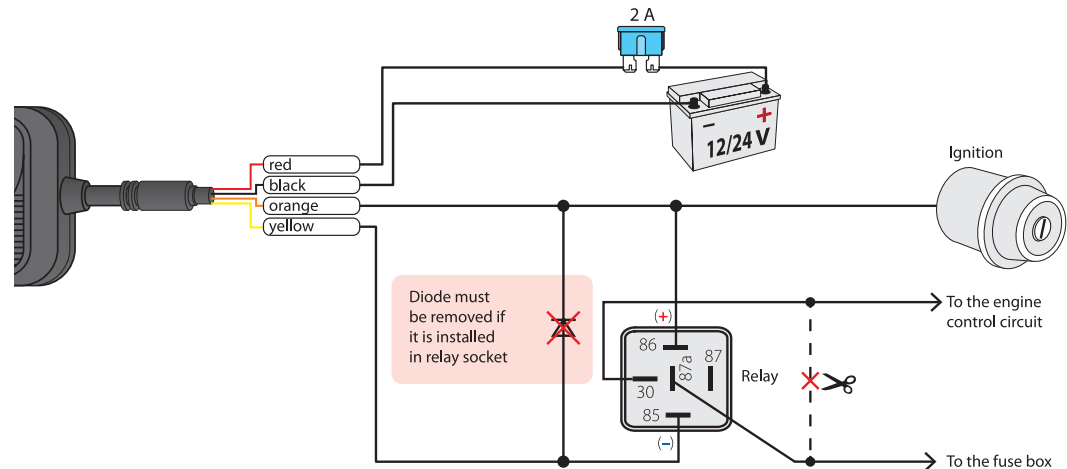

This wiring must be done by qualified technician.

CONFIGURATION



Prior to configuration make connections wiring and give power supply.

Record an owner phone number (SOS1) to device memory to be able control tracker and receive notifications.

All commands from SOS-number are sent without GSM password. Commands from other phones must be added with the GSM password between command text with comma and # symbol. For example, to request current position send the following text **POSITION,1234#**, where **1234** — GSM password, **POSITION#** — command text.

To record an owner phone number as SOS number (if not saved yet), or change SOS number without access to previously saved one, send the text command **SOS,XXXX,A,+XXXXXXXXXX#**, where

- XXXX** — GSM password (4 digits, by default 1234),
- +XXXXXXXXXX** — telephone number in international format that must be saved as SOS-number.

To change GSM-password after setting SOS-number make following:

- Send SMS-command **PWDSW,OFF#**
- After receiving a responding message send SMS command **PASSWORD,XXXX,YYYY#**, where **XXXX** – 4 digits of current GSM password, **YYYY** – 4 digits of new GSM password
- After receiving a responding message send SMS command **PWDSW,ON#**

SMS COMMANDS LIST

SMS commands	Description
POSITION#	Request current location
SOS,XXXX,A,+XXXXXXXXXX#	Set owner phone number, where XXXX - GSM password (default 1234), +XXXXXXXXXX - owner phone number
SOS,XXXX,D,+XXXXXXXXXX#	Delete owner phone number
SOS#	Request owner phone numbers
IMEI#	Request device IMEI to register on starline. online / mobile app
APN,NAME,LOG,PSW#	Set network access point, where: NAME - apn name, LOG - user login, PSW - password
GPRSSET#	Request network status
STATUS#	Request device status
PASSWORD,OLD,NEW#	Change GSM password, where OLD - old (default) password, NEW - new password
PWDSW,OFF#	Switch GSM password Off (from SOS1 owner number)
PWDSW,ON#	Switch GSM password On (from SOS1 owner number)
PRELAY,1#	Activate universal output (from SOS1 number only)
PRELAY,0#	Deactivate universal output (from SOS1 number only)
PARAM#	Request configuration parameters
RESET#	Reboot device
FACTORY#	Reset device to factory settings

REGISTRATION

1. Install StarLine 2 app or browse starline.online web service
2. Register a new StarLine account
3. Select Add device menu and follow the guide

